

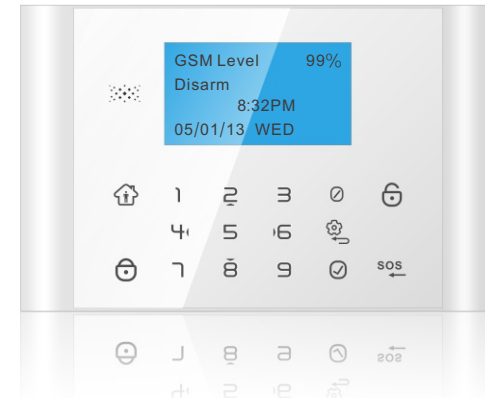

GSM&PSTN  
Alarm System



# Intelligent GSM&PSTN Auto-Dial Alarm System



## Profile

For a better understanding of this product, please read this user manual thoroughly before using it.



## CONTENTS

<b>I. Function Instruction.....</b>	<b>1</b>
<b>II. Alarm Panel Introduction.....</b>	<b>2</b>
<b>III. Initialization.....</b>	<b>4</b>
<b>IV. Function Settings.....</b>	<b>4</b>
1. Enter Settings.....	5
2. Time Setting.....	5
3. Alarm Call & SMS Number Setting.....	5
4. SMS Attention Number Setting.....	6
5. Voice Recording.....	7
6. Arm Delay Setting.....	7
7. Alarm Delay Setting.....	7
8. Timely Arm/ Disarm.....	8
9. Siren Setting for Alarm.....	8
10. Voice Prompt.....	9
11. Ring Time Setting.....	9
12. Add or Delete Wireless Sensors .....	9
13. Defense Zone Setting.....	9
14. Alarm Center Setting.....	11
15. User Password .....	12
16. Program Password.....	12
17. Wireless Siren Setting.....	12
18. Record Checking.....	12
19. Factory Reset.....	13
<b>V. Operation Instruction.....</b>	<b>13</b>
1. System status.....	14
2. Remote Controller Operation.....	14

## CONTENTS

3. Out Arm.....	14
4. Home Arm.....	14
5. Disarm.....	15
6. Emergency Help.....	15
7. Answer Alarm Call.....	15
8. Remote Control.....	16
<b>VI. Technical Parameters.....</b>	<b>17</b>
<b>VII. Components List.....</b>	<b>17</b>
<b>VIII. Care and Maintenance.....</b>	<b>17</b>



## I . Function Instruction

- ☆ Touch keypad and large dot-matrix LCD screen with perpetual calendar and detailed display;
- ☆ GSM and land line (PSTN) dual network alarm;
- ☆ Support 5 user alarm phone numbers (call or sms), 1 alarm center number and 1 SMS attention number;
- ☆ 30 wireless defense zones and 4 wired zones, each zone could be programmed individually, including the setting of defense zone type, sensor name, bypass, alarm delay;
- ☆ Support the function of 10-second voice recording, arm/ alarm delay, 100 alarm and status records saving;
- ☆ Arm/ disarm operation could be realized by main panel, remote controller, remote call, sms, and wireless keypad;
- ☆ One relay output to control home appliance;
- ☆ The alarm SMS content: defense zone number + sensor name;
- ☆ SMS alert for arm/ disarm, main panel battery low power, external power off/recovery, phone line failure, sensors low power;
- ☆ Support Ademco contact ID. Information that could be upload to the alarm center includes alarm, arm/disarm, battery low power, external power failure/recovery, period, manual test, and sensors low power.
- ☆ Compatible with all our accessories including digital video recorder, wireless siren, wireless keypad, etc;
- ☆ Support “Ding-dong” doorbell function; and alarm call has priority over normal phone call.



## II .Alarm Panel Introduction

In order to make the main unit get the wireless signal well for all wireless accessories, please put the alarm host at the central place of your defense area. Make sure it's away from large metal objects and household appliances which may cause high frequency interference, as well as barriers such as reinforced concrete wall or fire door, etc.

### Front schematic diagram:

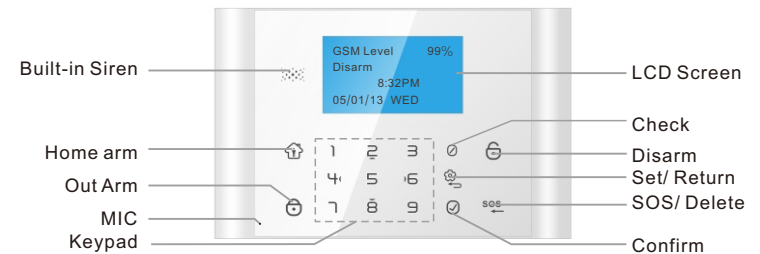

### LCD display:

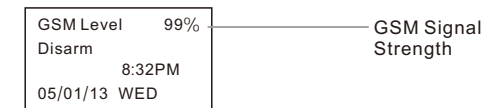

### Back schematic diagram:

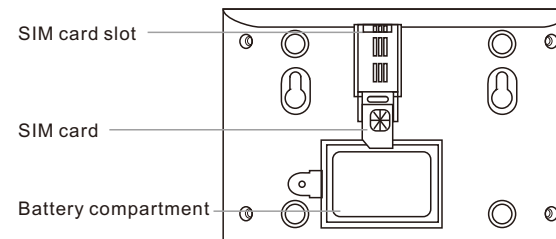



Wire ports:

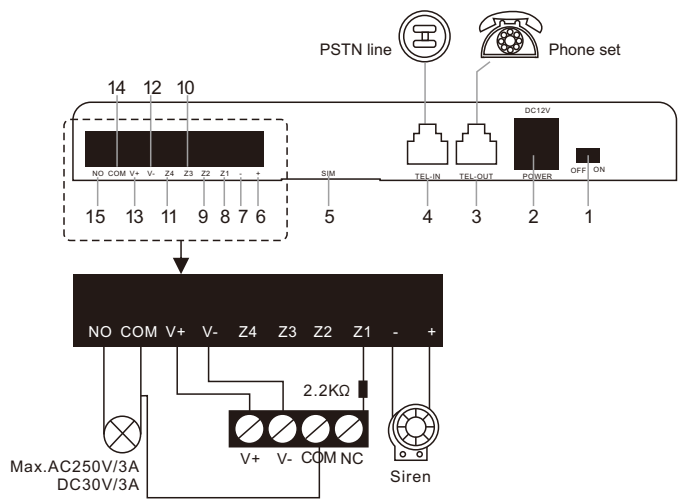

1	ON/OFF	Power switch
2	DC 12V POWER	Power adaptor port, 12V/1.2A
3	TEL-OUT	Connect telephone set
4	TEL-IN	Connect telephone line
5	SIM	SIM card slot
6	+	12V output (positive. Can connect wired sensor.)
7	-	12V output (negative. Can connect wired sensor.)
8	Z1	Wired sensor 1 (zone number: 31)
9	Z2	Wired sensor 2 (zone number: 32)
10	Z3	Wired sensor 3 (zone number: 33)
11	Z4	Wired sensor 4 (zone number: 34)
12	V-	Negative of siren (black cable)
13	V+	Positive of siren (red cable)
14	COM	GND
15	NO	Relay output. It will be closed for 3 minutes when alarm is triggered.

Keypad buttons instruction:

	out arm/ away arm
	home arm
	disarm:  +user password+
	check the alarm/ working status record. Press ,  to upturn or downturn.
	emergency alarm.

Indicating tone:

Keypad press	one short beep
Arm	one short beep
Out arm or alarm with delay	one short beep per second
Disarm	two short beeps
Telephone line error	two short beeps
External power failure	the screen will display "AC Power Fail"
Battery low power	one short beep
Remote call the main panel	one short beep each 3 seconds after getting through

III.Initialization

- 1)Put SIM card: please insert a valid SIM card into the card slot. (Please make sure the power is off.)
- 2)Connect telephone line: connect the telephone line in your house to the port "TEL-IN". There's a cable in the standard kit. It could connect your telephone set to "TEL-OUT".
- 3)Connect power: use the power adaptor to connect the panel to external power supply.
- 4)Turn on the backup battery: turn the power switch to "ON"

IV.Function Settings

- Note: 1) All the settings are found within the setting status.
- 2) Press to enter/ confirm/ save, to return and to clear the input content.
  - 3) Press key numbers , , , to turn up/ down/ left/ right.



4) If there's no operation over 30seconds, the panel would exit setting status automatically.

### 1.Enter Settings

Press , then input the 4-digit program password and to enter setting status. (default password: 1234)

### 2.Time Setting

After enter settings, you could see "clock setting". Enter it to set the time and date. The first group is for time (hour: minute: second), the second is for date (month/day/year) and the last is for day. Please press to clear the previous data and then input the correct data. And finally press to confirm.

### Operation figures:

Clock Setting
Phone No.setting
Sms Serring
Voice Recording

Clock Setting
14:35:21
05/01/2013
WED

### 3.Alarm Call & SMS Number Setting

This system can store 5 groups of alarm numbers. When alarming, it will make alarm call or send sms to these numbers. And the call will be made in order for three times automatically, until someone gets through it.

Method: enter "phone No. setting" menu, choose "Phone Alarm" or press to choose "SMS Alarm". Press and then delete the preset numbers. Input the number you want to set. Save it, then you will see the "phone group" change to "2" automatically. That means after setting a group of number successfully, it will enter the setting of next number automatically.

Note: Each group of number could not exceed 15-digit.

Each group of number can save only as phone call number or sms number.

The panel will handle the numbers in serial order. For example, you set the first number as sms number, and the second as phone number, it will send sms before making alarm call.



Phone Group 1
Phone Alarm >
SMS Alarm

Phone Group 1
Phone Alarm >
1358888888

Phone Group 2
Phone Alarm >

### 4.SMS Attention Number Setting

SMS attention number means the number that will receive sms when the external power is cut off or recovered, the system is armed or disarmed, the telephone line has error, etc. The sms content will also be displayed on the screen. This system can store 1 SMS attention number. **This number will not receive defense zone alarm sms.**

Method: enter "SMS Setting" menu, delete the preset numbers and then input the number you want to set. Save it, then you will see "AC Power Recover", "Arm/ Disarm SMS", "PSTN Off", "Battery Low-volt", and "Sensor Low-volt". Press to choose on or off. (System default: off)

AC Power Recover: when the external power supply is off more than 8 seconds, the panel will send sms "AC Power Fail"; when the external power supply is recovered for 30s, it will send sms "Alarm System: AC Power On".

Arm/ Disarm SMS: when system is armed or disarmed, it will send sms "Alarm System: Armed/ Disarmed".

PSTN Off: when the telephone line is cut for 5 seconds, the panel will send sms "Alarm System: PSTN Off".

Battery Low-volt: when the main panel battery is in low power, it will send sms "Alarm System: Low-volt".

Sensor Low-volt: when the sensor (PIR sensor, door contact sensor) battery is in low power, it will send sms "Sensor Low-volt".

*NOTE: This version alarm system does not have "sensor Low-volt" function. Please kindly contact us if required.*

SMS Phone No
1358888888

AC Power Recover
Off/On >

Am/Disarm SMS
Off/On >

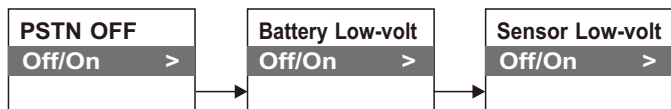

### 5.Voice Recording

Enter "Voice Recording" and press **4,6** to choose on. Enter it; you can start the 10-second recording. After 10s, it will exit automatically. Press **⏏** or **⏹** can end the recording manually. Receivers can hear this recording when there's an alarm call.

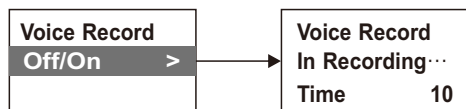

### 6.Arm Delay Setting

Enter "Arm Delay" menu. Delete the preset time and input the time (00~59seconds) you want to set. After this setting, when you arm (home arm/ away arm) the system, it will enter arming status after the preset delay time. (system default: 10s)

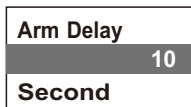

### 7.Alarm Delay Setting

Enter "Alarm Delay" menu. Delete the preset time and input the time (00~59seconds) you want to set. After this setting, when there is an alarm, it will make call or send sms after the preset delay time. (system default: 10s)

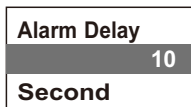

### 8.Timely Arm/ Disarm

After this setting, the alarm system will start arm status and disarm automatically at the preset time.

Method: enter "timely arm/disarm" menu. You will see the screen displays like the following diagram. "SUN" means Sunday. Delete the preset time first and then input the time you want to set (00:00~24:59). After saving, it will change to "MON" automatically. That means, after each successful setting, it will change to the next day.



### 9.Siren Setting for Alarm

The siren can be set on or off when there's an alarm.

Enter "Siren Setting" menu. You will see "Zone No.". Delete the preset numbers and input the defense zone number (00~34) you want to set. Save it and then set the "Siren Duration" (00~59minutes). Save it and then set the "Built-in Siren". Press **4,6** to choose on/off.

Siren Duration: siren ring time (default: 1minute)

Built-in Siren: the siren built-in the alarm panel

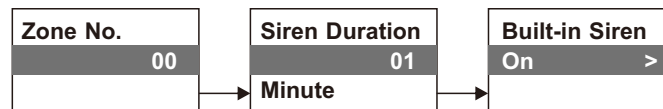

### 10.Voice Prompt

Enter "Voice Prompt" menu, you can set these functions "PSTN Off" "Arm & Disarm Siren" "Arm & Disarm Horn" as on/ off.

PSTN Off: turn on this function; the screen will display "PSTN Off" when the telephone line is cut off. The panel will make two short beeps at the same time.

Arm & Disarm Siren: turn on this function, the built-in siren of the panel will make one short beep for arm operation and two short beeps for disarm.



## Function Settings

Arm & Disarm Horn: turn on this function; the extern siren will make one short beep for arm operation and two short beeps for disarm.

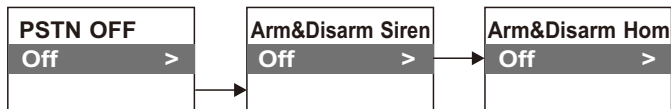

### 11.Ring Time Setting

When you use phone to call the alarm system and do remote control, it will get through after several rings. This ringing times could be set (1~9).

**Method:** Enter "Voice Prompt" menu, then set the times of "Tel Ring Time" and "SIM Ring Time".

Tel Ring Time: the ringing times when you call the landline number (system default: 6)

SIM Ring Time: the ringing times when you call the SIM card number (system default: 3)

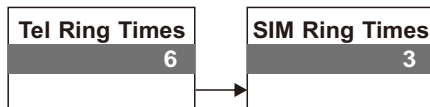

### 12.Add or Delete Wireless Sensors

This alarm system has 30 wireless defense zones, each of which supports up to 4 wireless detectors. And it supports up to 10 remote controllers. Extra sensors and remotes have to be set with the alarm panel in order to perform normally. Zone 00 is for remote controller and zone 01~30 are for wireless sensors.

**Method:** Enter "Pairing & Deleting" menu. Delete the zone No., and then input the number (00~30) you want to set. Press **⏏** to choose "Pair", you will see "in paring". At this time, you can trigger the remote controller or sensor. **Please trigger it twice.** The screen will display "operation ok" after successful setting. Choose "Delete", you will delete all the sensors in this chosen defense zone.

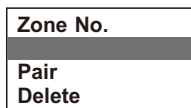

### 13.Defense Zone Setting

Enter "Zone type" menu, then delete the previous zone number and input the number (01~34) you want to set. Then you could do the settings.

**Zone activate/disable:** this means you want this zone work or not

**Defense line:** 0: 24-hour defense zone; 1: out arm zone; 2: home arm zone



## Function Settings

**00 SOS help:** alarm information

**Alarm Delay Off/On:** press 4/6 to choose to activate alarm delay function or not

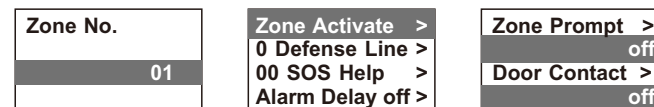

System default setting for all zones:

List 1

Zone number	Zone type	Zone on/off	Alarm delay
00	---	On	Off
01~10	24-hour zone	On	Off
11~20	Out arm	On	Off
21~29	Home arm	On	Off
30	Doorbell zone	On	Off
31~34	---	Off	Off

List 2

Zone No.	Alarm Information	CID code	Zone No.	Alarm Information	CID code
01	00 SOS Help	E100	18	15 Glass Alarm	E131
02	00 SOS Help	E100	19	18 Garage Alarm	E130
03	01 Panic Button	E121	20	09 Out Arm	E131
04	02 Panic Button	E120	21	19 PIR Alarm	E132
05	03 Fire Alarm	E110	22	19 PIR Alarm	E132
06	03 Fire Alarm	E110	23	19 PIR Alarm	E132
07	05 Kitchen Alarm	E130	24	20 Living room	E130
08	15 Glass Alarm	E131	25	20 Living room	E130
09	15 Glass Alarm	E131	26	21 Bedroom Alarm	E130
10	07 Tamper Alarm	E137	27	21 Bedroom Alarm	E130
11	10 Door Alarm	E134	28	21 Bedroom Alarm	E130
12	10 Door Alarm	E134	29	18 Garage Alarm	E130
13	11 Front Door	E134	30	24 Doorbell	
14	12 Back Door	E134	31	10 Door Alarm	E134
15	13 Side Door	E134	32	09 Out Arm	E131
16	14 Window Alarm	E131	33	09 Out Arm	E131
17	14 Window Alarm	E131	34	19 Out Arm	E132



### 14. Alarm Center Setting

Enter "CMS Upload" menu, you can do all the following settings:

**CMS No. Setting:** this is the alarm center number (this number could not exceed 15-digit).

**User ID Setting:** delete the preset numbers and input the new ID (0001~9999). (default: 0001)

**Status Upload:** press 4,6 to choose on/off. Turn on this function; the operation of arm/ disarm will be uploaded to the center. System default is off.

**AC Power Fail:** press 4,6 to choose on/off. Turn on this function; when the external power supply is off, the panel will send information to the center. System default is off.

**Battery Low-volt:** Turn on this function; when the main panel battery is in low power, the panel will send information to the center. System default is off. System default is off.

**Sensor Low-volt:** Turn on this function; when the sensors (PIR sensor, door contact sensor) battery low power, the panel will send information to the center. System default is off. *This version alarm system does not have this function. Please kindly contact us if required.*

**Manual test:** Turn on this function; all the operations and settings of the main panel will be uploaded to the center. System default is off.

**Period Time:** 00001~99999minutes 00000 means off.

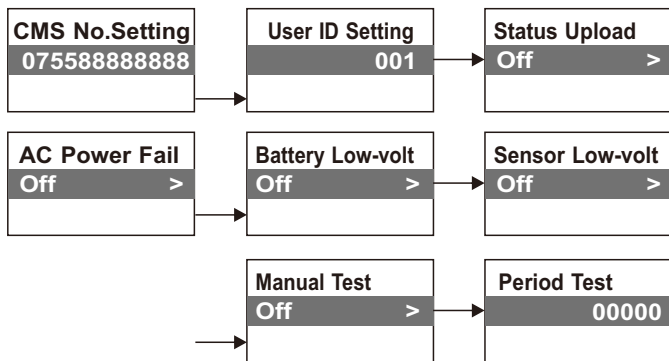

### 15. User Password

This password is used to disarm the alarm system by panel keypad. This system supports 3 user passwords (A, B, C). Password A is also the remote call password.

**Method:** Enter "Password Setting" menu. Delete the previous numbers and input the new 4-digit password. (System default: 1234) When users use these passwords to disarm, there would be sms to distinguish them. For example:

Disarm with password A: (XXXX) alarm system A: Armed  
XXXX is the user ID (refer to the part "alarm center setting")

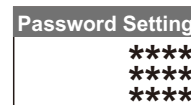

### 16. Program Password

The program password is used to enter setting status. The default is 1234. Users can change it.

Enter "PIN Setting" menu; delete the previous numbers and input the new 4-digit password.



### 17. Wireless Siren Setting

If you want wireless sirens to work together with this alarm system, you need to set them first.

Set the wireless siren into coding status (refer to siren user manual), and then press button <sup>sq</sup> on the main panel for 2 seconds. The main panel will send wireless signal to the siren, and the siren makes two beeps after receiving it. The setting is successful and the siren could exit coding status.

### 18. Record Checking

In standby status, pressing "0" button on the panel could check the





alarm and working record. Press 4,6 to upturn or downturn. This system can store 100 records. The last status is ranked as the first record. And when the record number exceeds 100, the most previous record will be deleted automatically.

03:Working Log  
Armed  
01/01 09:37 AM

07:Alarm Log  
00 Defense Zone  
SOS Help  
01/05 04:42 PM

### 19.Factory Reset

When the system is unstable, it is recommended to reset it. In setting status, enter "Factory Reset" menu, and then press 4/6 to choose on. And save this setting. After this operation, all the settings return to factory default, and the alarm records would be all deleted.

Factory Rest  
On >

## V.Operation Instructions

1.System status. There are 4 statuses as following:

Arm/ away arm: all detectors will be in working status

Home Arm: in arm status, the defense zone which is set as [Home Arm Zone] will not make alarm when detectors are triggered; only detectors in out arm zone and 24-hour zone will trigger alarm

Disarm: the system will not alarm when detector triggered (except 24 hours defense zone)

System setting status: In this status, all defense zones will not alarm when detectors are triggered.

### 2.Remote Controller Operation

Users can use remote controller to set system as Out/ Away Arm, Home Arm, Emergency Alarm, and Disarm.



- Out Arm: Press Ⓜ button
- Disarm: Press Ⓜ button
- Home Arm: Press 🏠 button
- Emergency Alarm: Press SOS button, system will alarm at once.

### 3.Out Arm

It means to guard all around your house while everyone is going out; all the detectors of the host are always working; when the detector is triggered by detecting source (anti-theft, fire prevention, gas leak, etc.), the alarm system will sound the alarm.

Main unit operation: Press Ⓜ button, the system will enter arm status 10seconds later or after the delay time set by user

Remote controller operation: Press Ⓜ button on remote controller, system will enter OUT ARM status

SMS operation: user password (Default: 1234) + [1]

After the setting, the panel makes "Di" sound, and you will receive a SMS: Alarm System armed.

LCD display:

Away Arm  
4:43PM  
01/16/13 WED

### 4.Home/Stay Arm

Home arm means part of the defense zones are in arm status. When there's someone at home, it is recommended, for safety purpose, to



## Operation Instructions

enable some of the detectors (such as sensors for door, window, balcony, etc), and disable the others (such as sensors for the hall or some places easy to be triggered by person at home).

Main unit Operation: Press button on keypad

Remote Control Operation: Press button on remote controller once  
LCD display:

Home Arm  
4:45PM  
01/16/13 WED

### 5.Disarm

The purpose of disarming the system is to let it not in alert status. One way is normal disarming after operation of arming, and the other is to stop the main unit alarming. After the operation of disarm, all the defense zones except 24-hour zone shall not work.

Main unit Operation: + user password +

Remote Control Operation: Press button on remote controller

SMS operation: user password (Default: 1234) + [0]

After the setting, the panel makes "Di" "Di" sound, and you will receive a SMS: Alarm System disarmed.

LCD display:

Disarm  
4:46PM  
01/16/13 WED

### 6.Emergency Help

Sometimes, there may be some accidents happening (a senior person or child suddenly becoming ill or being in great pain, a fire emergency, burglar intrusion). Press [SOS] button on keypad, or SOS button on remote controller or wireless panic button, the main unit will alarm and make calls to the preset user numbers.

### 7.Answer Alarm Call

When the main unit sounds alarm, it will dial the preset alarm center



## Operation Instructions

and user phone numbers. If no one answers the call, the system will call the next user number automatically. The system will call each preset numbers for 3 times in order.

If you hang-up directly without answering the call, the system will call each preset number for 3 times circularly.

If you answer the call, you will hear the pre-record voice. You can set system via your telephone or mobile phone keypad.

**Press [1]:** Main unit stops alarming and Arm; the call is hung up directly and it stops calling users.

**Press [2]:** Main unit stops alarming and Disarm; the call is hung up directly and it stops calling users.

**Press [3]:** Turns the siren off and monitors the scene for 30 seconds. Within the 30s, you can press 1/2/4/\*. And if there's no operation for 30s, it will hang up automatically.

**Press [4]:** Replays the pre-recorded voice. After this operation, you can still press 1/2/3/\*.

**Press [\*]:** Hang up the call and stops alarming.

Note: the alarm SMS number will receive alarm message: Alarm System + zone number + alarm type.

### 8.Remote Control

Dial the number associated to the alarm panel by phone (mobile phone), and after one ringing cycle, you can hear a "Di" sound. Then press "user password A+#". A "Di" sound indicates operation correct, and now you can:

**Press [1]:** out arm; the call is hung up directly

**Press [2]:** disarm; the call is hung up directly

**Press [3]:** monitoring for 30 seconds. Within the 30s, you can press 1/2/4/\*. And if there's no operation for 30s, it will hang up automatically.

**Press [4]:** Replays the pre-recorded voice. After this operation, you can still press 1/2/3/\*.

**Press [\*]:** Hang up the call.



## VI. Technical Parameters

### Main panel

Input voltage: DC12V/ 1.2A  
 Standby current: <50mA  
 Alarming current: <500mA  
 GSM band: 850/900/1800/1900MHz  
 Wireless frequency: 315/433/868MHz (default: 433)  
 Backup battery: 3.7V/ 1200mA LI rechargeable battery  
 Standby time: 10~12hrs  
 Recharging time: 12hrs  
 Working Temperature: 10 ~+40  
 Humidity: 90% ( no fog)  
 Wireless detectors: 120pcs

## VII. Components List

Main panel	1 pc,
Remote controller	2 pcs,
Siren	1 pc,
Wireless PIR sensor	1 pc,
Wireless door sensor	1 pc,
Telephone line	1 pc,
Power adapter (DC 12V/1.2A)	1 pc,
User manual	1 pc.

## VIII. Care and Maintenance

The alarm system has excellent design and uses advanced technologies. It shall be used with care. The following suggestions are required to maintain your obligations under the warranty terms, and for prolonging the service life of the system.

Place the control panel and all parts and accessories out of children's reach.

Keep the alarm system dry. Rain, humidity and various fluids or moisture all will corrupt the electronic circuit.

Do not use or place the alarm system in dirty locations, otherwise the electronic elements will be damaged.



☆ Do not place the system in excessively hot locations. High temperature will shorten the service life of electronic equipment, damage batteries, deform or even melt some plastic parts.

☆ Do not place the system in excessively cold locations. Otherwise condensation may occur and damage the circuit board of the alarm system.

☆ It is recommended that you check and test the alarm system periodically:

### Check the main unit every three months:

1. Whether it can arm/disarm normally;
2. Whether it can dial the number for alarm normally;
3. Whether it can receive wireless detectors' signal normally;
4. Whether the back-up battery can work normally.

### Check the wireless detectors once a month:

1. Trigger wireless detectors to see if system can alarm normally;
2. Check all detectors' batteries to see if it's in low voltage;
3. Check whether wireless detectors can send signal to the main unit normally.

### Check the SIM card:

1. Check the use of SIM card, such as network signal, balance, etc.
2. Make sure the PIN code verification of the SIM card is closed.
3. Please keep the password and SIM card number safe, in case that other people remote control the system illegally.

Since the alarm system is continuously in operation or standby mode, the supply adaptor of the control panel shall be connected to a safe and reliable socket.

☆ Do not place the system near your bedroom or office table, because the siren will make high-loudness sound in the case of alarm, which may adversely affect your rest or work.

☆ If the alarm system will not be used for a long time, please disconnect the system from the power supply.

☆ Please do not disassemble, repair or alter the products without permission, or it may cause accidents and faults.

☆ Do not drop this product on the ground or on hard objects, as it may lead to massive impact to cause faults and damages.



☆ Without approval and consent of relevant authorities, please do not set “112”, “911” or the alarm phone number of police station for this main unit.

Please read the suggestions above carefully and follow the instructions herein. If any of the equipment does not work properly, please send it to the dealer or authorized service point for repair. We will try our best to solve the problem for you as soon as possible.

The following accessories are optional:



Signal booster



Wireless Keypad



Wireless Outdoor Flash Siren



Door sensor



Panic Button



Remote controls



Smoke Detector



Gas Detector



PIR detector

Optional sensors/detectors are packed separately. You can choose according to your specific requirements.

